



1 Watch.

2 Point to the jobs.

photographer

artist

engineer

astronaut

teacher

nurse

3 Play the Guess who game with a classmate.



Are you a **girl**?

Yes, I am.

Are you **an astronaut**?

No, I'm not.

4 What do you want to be? Draw yourself.

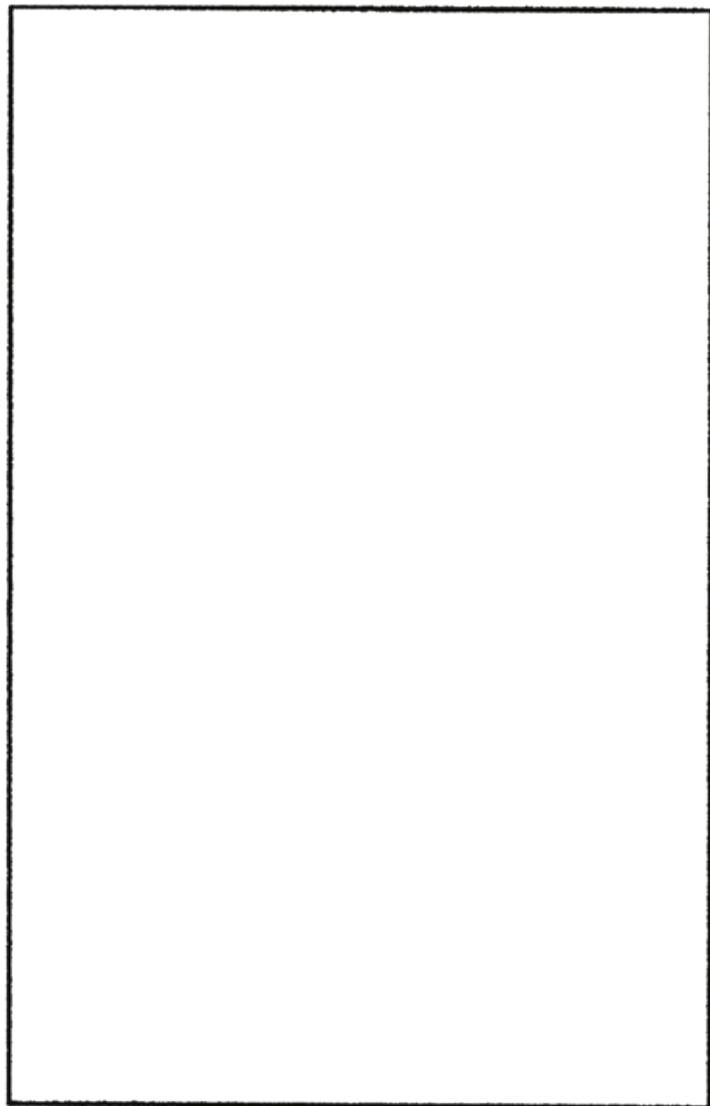
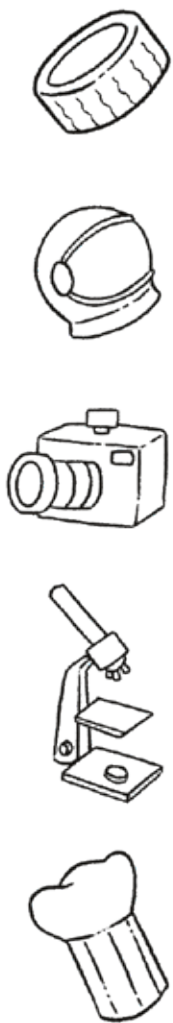

5 5 Talk with your classmate.

Talk about art



a scientist



a farmer

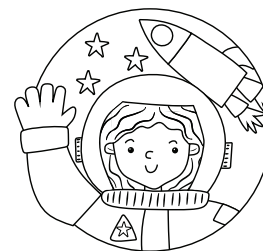

an astronaut

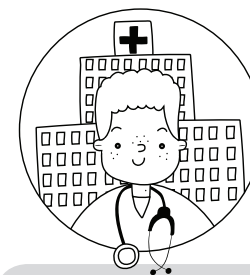

a nurse

I want to be ...



How can we create patterns?

We can use **lines**, **dots** and **shapes** to create different **patterns**.

1 Find and circle the details in the artwork.

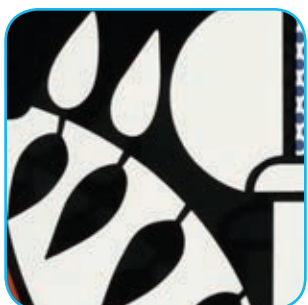

Peace Through Chemistry I, Roy Lichtenstein, 1970

2 Describe the illustration.

Talk about art

woman

microscope

black

man

beaker

white



I see a ...
scientist.

Create!

3 Watch.

Use the pop-out!

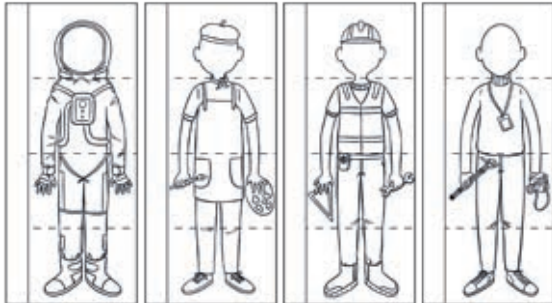

4 Complete the patterns.

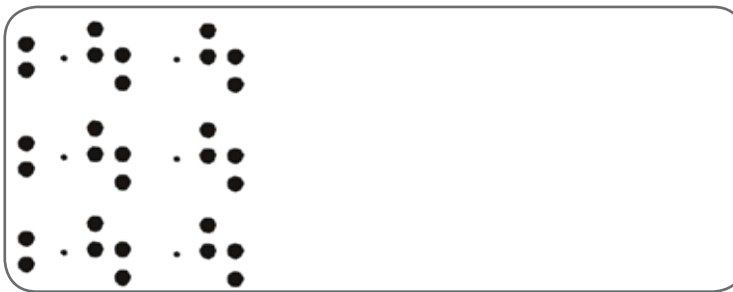

dots



3D dots



zigzag



Greek key

5 Make a Jobs book. Decorate the book with patterns.



Review

6 Tick.

Have you got ...?

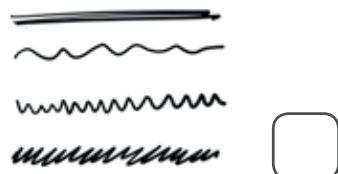

lines

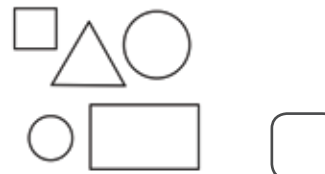

shapes



colours



How can we show sound and movement in comics?

In comics, we can show movement with **motion lines** and sound with **sound effects**.

1  Look and match.

Thinking routine

Act it out!



motion lines



sound effects

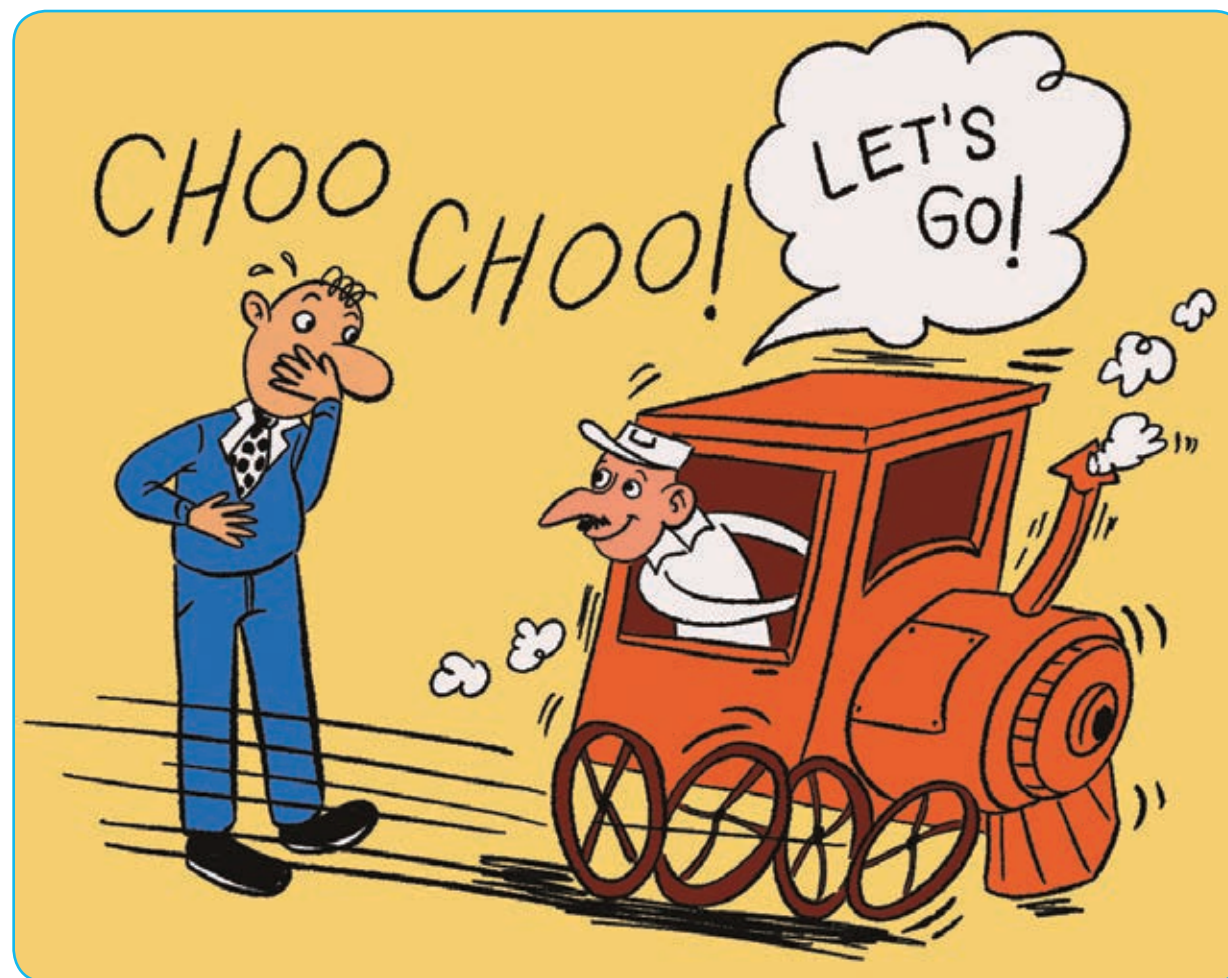

At home

Find sound effects and motion lines in your favourite comics.

Create!

2 Complete the comic with motion lines and sound effects.

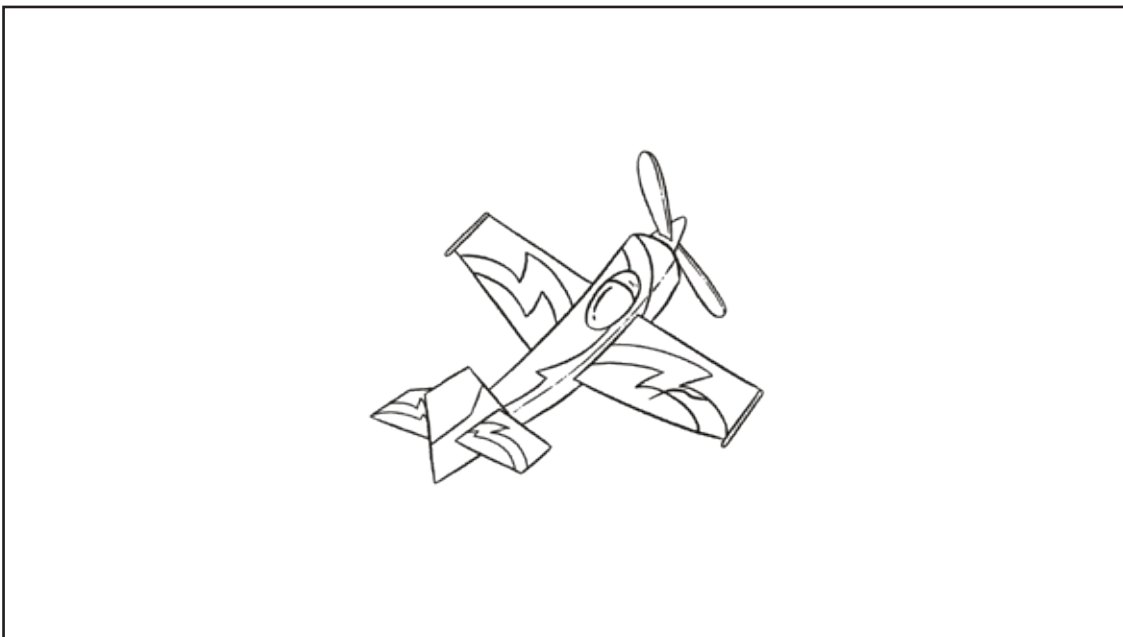
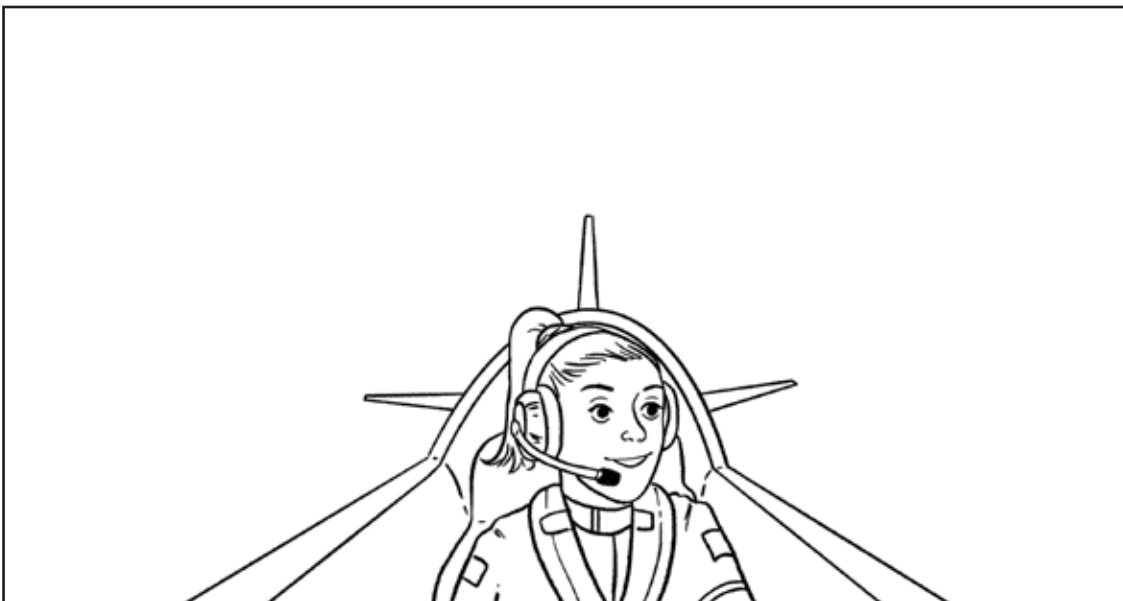

Be mindful

001 Listen to the sound effects.



Draw a sound effect to show how you feel.

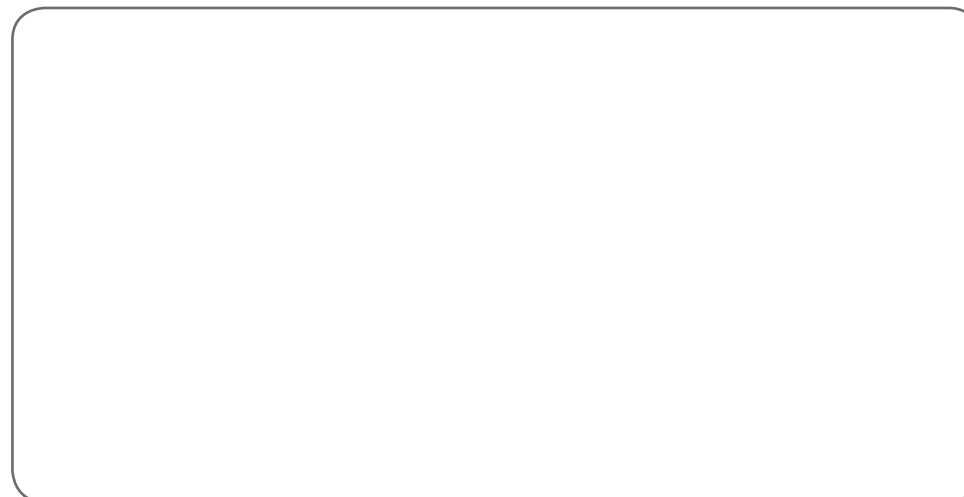

What are shots in photography?

Shots are the space you see in a photo. You can take **full shots**, **medium shots** and **close-up shots**.

1 Look and colour the frames.

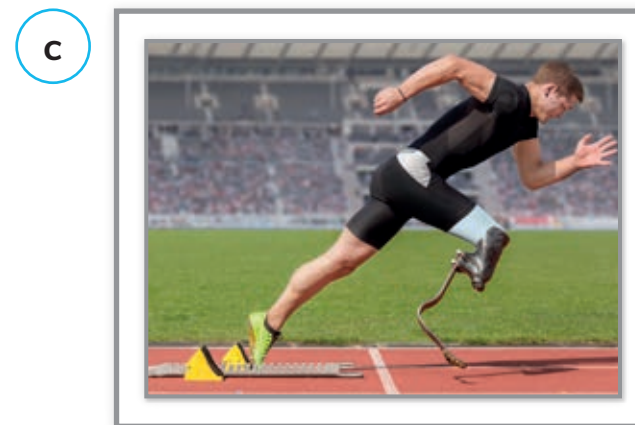
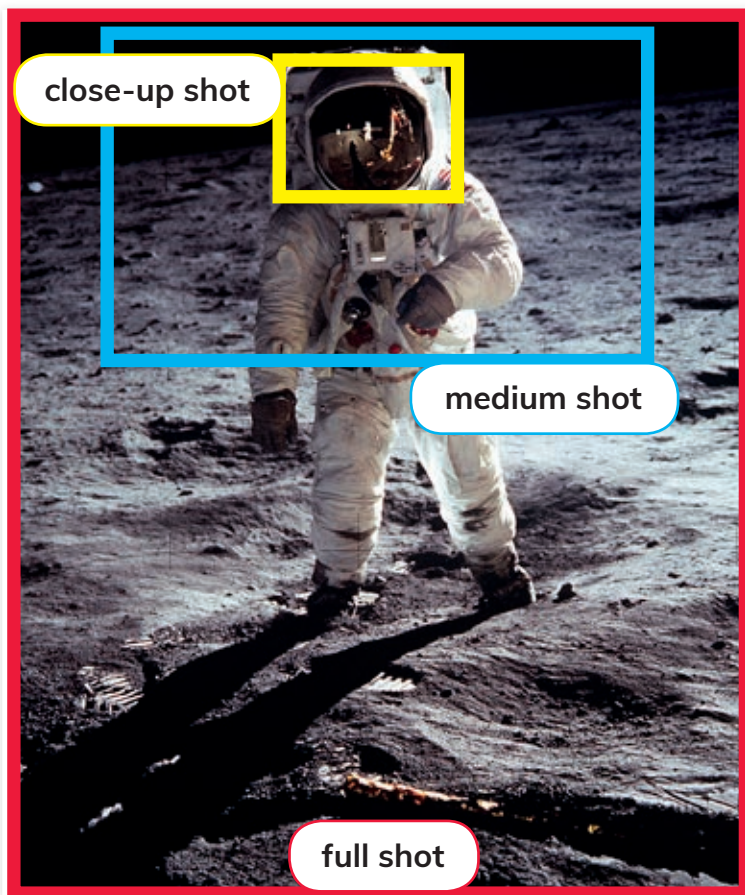

2 Look and say.



This is a **full shot**.

This is a **medium shot**.



Create!

3 Draw the photos.



full shot



medium shot



close-up shot

4 📷 Take photos using different shots.

Reflect

5 Read and colour the stars.

I can ...

create patterns. ☆ ☆ ☆

I can ...

draw motion lines. ☆ ☆ ☆

I can ...

take photos. ☆ ☆ ☆



Challenge

Be a paper plane engineer



Which plane flies the best?



Materials:
paper, coloured pens

Step 1

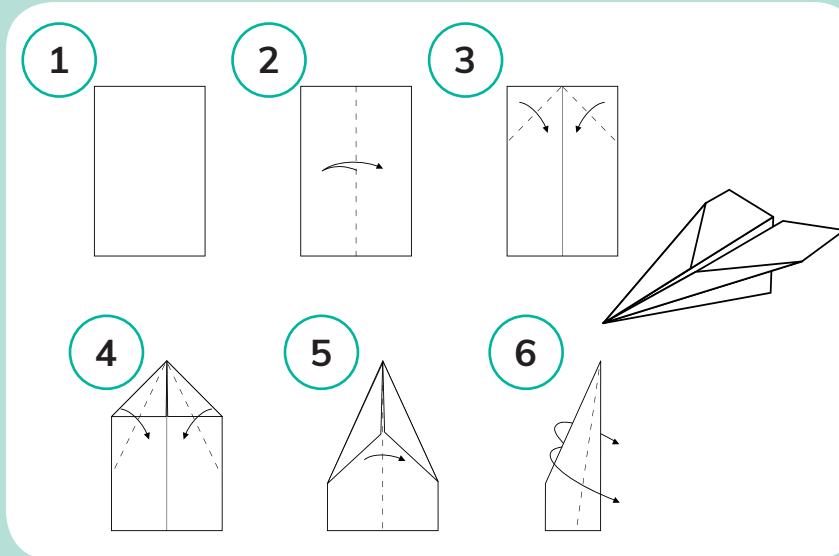

Make and decorate your paper plane.

Step 2



Race your planes.

WOW The best paper plane in the world can fly 77 metres!

Imagine and create

GREAT WORK IS TO
LOVE WHAT YOU DO

