

Units 7-9 | Test

Listening

1 T4 Listen and number.

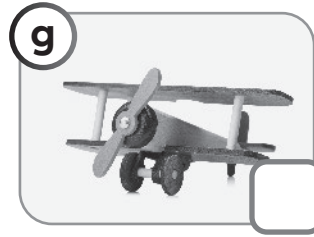
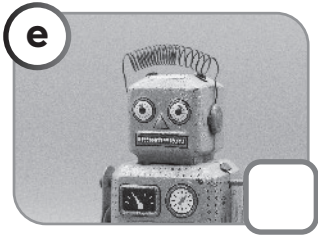
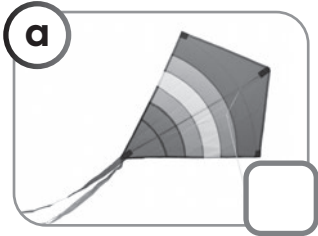

Speaking

8

2a Point and say. It's

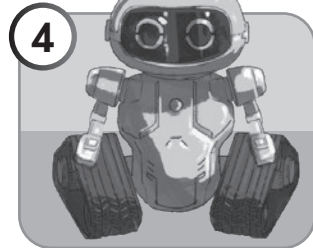
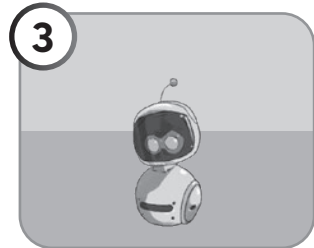

4

2b Point and say.

That's my



4 **1** **me**

4

Name

Reading

3 Read and circle.

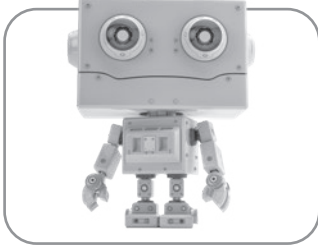

1 I've got a robot / doll.
It's small / big.

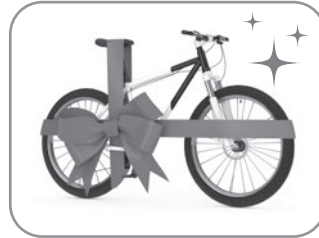

2 I've got a bike / kite.
It's old / new.



3 I've got a teddy bear / plane.
It's cool / old.



4 I've got a plane / kite.
It's big / small.

8

Writing

4 Choose and write.

dad brother grandpa mum



1 That's my



2 That's my

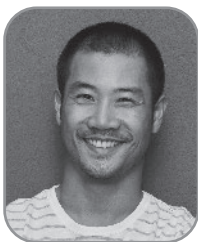

3 That's my



4 That's my

4

5 Look and write 've got or haven't got.

1



I a doll.

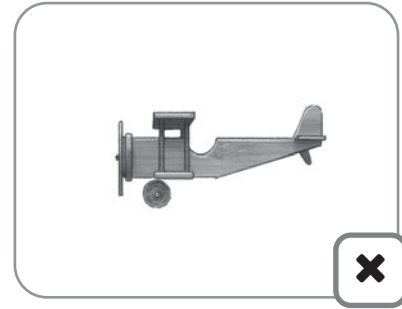

I a plane.

2

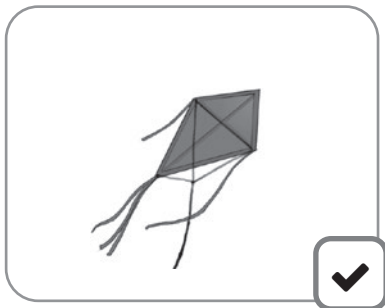

I a kite.

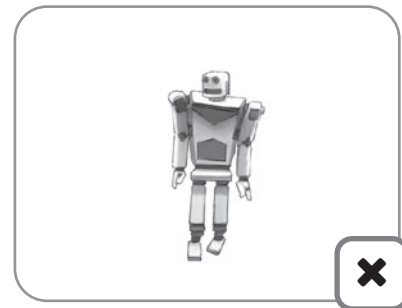

I a robot.

4

How do you feel about the test?



happy



OK



disappointed



Test score

32